

XD: 1200.6

Full Range Class D Amplifier

Introduction	1
Finding a Suitable Location	1
Supplying Power	1
The Ground	1
Running the Cables	2
Class D amplifiers	2
Diagnostic Fault Codes	2
Controls and Features	
Inputs	3
Gains	3
Crossovers	3
Remote Level Control	3
Bass Boost	4
Ohm Load Matching	4
Speaker Outputs	4
Bandpass Crossovers Explained	5
Installation Instructions	7
System Diagrams	
4 Channel Stereo W/Subwoofer	8
3-WAY ACTIVE	
TWEETER/MIDBASS SUBWOOFER	9
3-WAY MIXED ACTIVE	
TWEETER/MIDRANGE	
MIDBASS SUBWOOFER	10
3-WAY ACTIVE	
TWEETER MIDRANGE MIDBASS	11
BRIDGED 3 CHANNEL	
STEREO FRONT WITH SUBWOOFER	12
Input Select Switches	13
Auto Detect	14
Speaker Level Input	14
Specifications	15
Warranty	15

Thank you for purchasing an ARC Audio Hi-Performance Amplifier.

This ARC Audio amplifier uses a Full Range Class D architecture that significantly improves efficiency, lowers heat output and current draw. Don't be fooled by the small size. Class D amplifiers make more power for their size than traditional designs making installation a breeze without compromising storage space.

ARC Audio...**SOLID CONSTRUCTION for SOUND Car Audio Systems.**

Warning

We build all ARC Audio products to play at high volumes for extended periods of time. Your ears however are not designed for high volume listening. This product can easily generate volumes that can permanently damage your hearing. We urge you to limit your exposure to very high volume sound.

You may also find your state has laws governing the volume of an audio system in a car. Please be aware of all local and state laws in your area.

A properly tuned and operated audio system will deliver years of enjoyment when used properly.

Installation Instructions

ARC Audio XDi Amplifiers are designed for easy installation in your vehicle. To ensure proper operation of your new purchase, please follow the suggestions we have listed below:

Warning

Please check the suitability of the installation location before you begin. Do not cut any of the car's structure. Pay close attention to what is behind the panels or carpet. Often the manufacture will hide wires, computers or other electronic devices in the exact areas you wish to install in.

If you do not have experience with automotive electrical and mechanical systems contact a professional installer. Paying a qualified installer is almost always cheaper than paying a dealership to repair your car.

Locating the Amplifier

The amplifiers must be securely mounted to a solid surface. Please select a dry location in the trunk or passenger compartment only. Do not mount the amplifier to any area that may have excessive vibration (like the subwoofer box). Position the amplifier in an area that receives sufficient airflow for proper heat dissipation.

Supplying Enough Power

The Laws of Nature

Your amplifier Does NOT make power. It converts power, or current, from your cars electrical system and turns it into a high power musical energy. If the amp can't get all the power it needs it will not produce its full output. Your ARC Audio amplifier will produce Full output for longer than other amps on the market today. If the Voltage or Current drops too low even our amplifiers will drop below their rated output. Make sure your vehicle charging system is in good working order. Any Hi-Performance audio amplifier will increase the demand on your alternator and battery. If you are unsure have your charging system tested by a professional technician.

The Ground!!!

Warning: Read this Carefully

The ground wire should be connected directly to the chassis of your vehicle. Find a clear location close to the amplifier and remove all the paint and sound deadener. Use a #10 or larger screw to secure it. A nut, bolt and lock washer would be better still. Never use seat belt bolts for grounding.

Remember, the ground must carry the same high current as the positive power wire.

To reduce the risk of noise, run all signal cables away from any vehicle or power supply wiring.

Running the Cables

Carefully run the power and signal cables through the passenger compartment of the vehicle. Running power down one side and signal down the other is the preferred method. If this isn't possible, keep them separated as much as possible. When running through any metal, always use a rubber grommet to prevent the power wire from shorting and to reduce the risk of fire. A 4 gauge or larger wire should be used for power and ground connections. ALWAYS install a fuse on the power wire within 18 inches of the battery for safety.

Recommendations for all Class D amplifiers

Class D amplifiers by the nature of their design emit a certain amount of RF (Radio Frequency) radiation. While we have optimized the design to reduce this to a minimum level there are still steps you can take to eliminate any unwanted FM radio interference. The tips below apply to any class D amplifier.

Always mount the amplifier as far from the antenna as the installation will allow. At the same time you will want to keep it away from the radio or any other electronics that may prove to be sensitive to FR radiation.

Make the ground wire as short as possible. Think of the ground like it is an antenna. Short antennas do not work as well.

Use twisted pair wires as much as possible. If you can manage it all the speaker wire and input cable weather by RCA or speaker level should be twisted. If you do not have twisted pair wire you may be able to twist it yourself.

If you encounter a problem with FM interference you can try turning the amplifier 90 degrees or changing its location completely. RF radiation can be very directional.

Warning

Take extra care when using CCA (Copper Clad Aluminum) or pure aluminum wire to insure the connections as clean and tight. Do to aluminum's highly reactive nature these connections can fail without the typical "Green" or tarnished look you would expect with copper. Aluminum also has a greater rate of expansion do to heat and care must be taken to insure that the connection is not over tightened. This can result in the failure of the power or ground connector and possibly the circuit board.

DIAGNOSTIC FAULT CODES

Thermal (Heatsink) The Amplifier has Over Heated. Turn the volume down and let it cool off.	
Thermal (Transformer) The Power Supply Transformer has Over Heated. Turn the volume down and let it cool off.	
Code 11 Under Voltage The Battery Voltage is too low. I bet your car won't start. If it does, you have a bad connection.	
Code 12 Short (Low Power Channel) Shorted speaker or wire on Channels 1-4. Turn the system off until you can get this fault corrected. Also includes internal shorts.	
Code 13 Repeated Shorts You didn't turn the system off, did you?	
Code 14 Over Voltage Your Alternator is Over-Charging. Have your vehicle's electrical system tested right away.	
Code 15 DC Output Protection DC Current was detected on the speaker line and to avoid damaging the speakers, this amplifier has shut down. This will probably require factory service.	
Code 16 Short (High Power Channel) Shorted speaker or wire on subwoofer channels (5 or 5-6) also includes internal shorts.	
Normal Turn on Blue is good. This is normal self test and turn on delay.	
Power/Processor Reset You will see this the first time the amplifier is powered up or the microprocessor resets. This code will vary from model to model.	

Input Section

This XDi amplifier is equipped with a Balanced Input Stage that is compatible with any analog source including Balanced and Unbalanced RCA, Common ground speaker level output or BTL (Bridged Tied Load) outputs common on many OEM headunits. The RCA pigtailed included with this amplifier are intended to be used to speaker level outputs and include a divider network molded into the end to reduce the level of the OEM system. **If you are integrating into an OEM systems balanced or common ground line level signal you should not use these Pigtailed.** In this case it is recommended that you use an appropriate RCA cable with 1 set of ends removed as inputs for the amplifier.

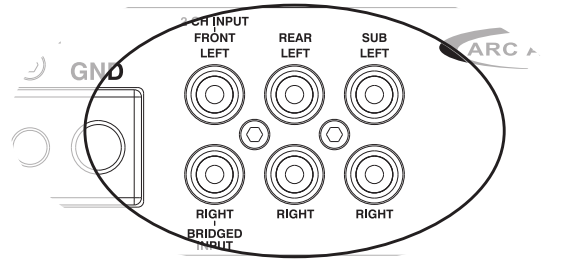

Gain

Because of the wide range of head unit output configurations all ARC Audio amplifiers have an adjustable input sensitivity or "Gain". The gain is not a volume or a power limiting control like a throttle. It makes the amp more sensitive to input from the stereo. With the gain up the amp will reach full output at a lower volume setting on the deck. At higher gain settings the amp also becomes more sensitive to noise from the car's electrical system. Try to run the gain at the lowest setting possible for you system.

There is no correct gain setting. Because speakers require different power demands to reach the same output, the gains most often need to be used to compensate for these differences. If you tried to set all the gains at half way you would probably find the system didn't sound very good. Using good judgment and listening carefully to each speaker is still the best way to tune a system.

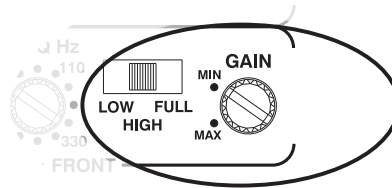

Crossover Controls

A crossover is a device that removes unwanted frequencies from a speaker or amplifier. A tweeter can easily be destroyed by bass notes if they are not filtered out. Likewise a subwoofer will not sound natural if it is playing midrange notes. A crossover removes these sounds from the speaker. As you might guess, careful adjustment is needed to ensure that all the speakers are playing the right sounds and that you are left with no "holes" or low spots in the frequency response.

NOTE: Some of the crossovers on this model include a X10 switch. This has the effect of multiplying the frequency you set on the knob by 10. If the control is set to 50Hz with the X10 applied the actual frequency will be 500Hz.

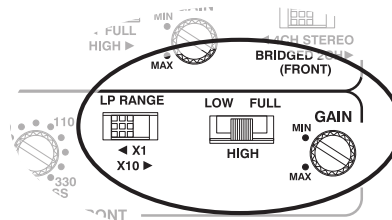

Remote Level Control

This amplifier is equipped with a remote level control for the SUB channels. This level control is used in conjunction with the LOWPASS crossover. *It DOES NOT work in highpass or full range.* This control has the effect of reducing the gain by -12dB. To use this control, set the gains to the maximum (**SAFE and undistorted**) volume you would use. The remote is then used to adjust this level down to a normal level. It will not mute these channels completely.

This **Does Not** control the Bass Boost.

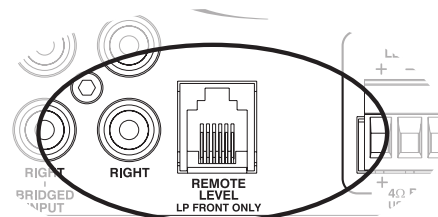

Bass Boost

This amp has an adjustable Bass Boost that is directed to the SUB channels. When laying out your system, if you plan to use Bass Boost (Example: Running a Bridged Subwoofer), connect those speakers to the front channels. Begin your adjustments at a low volume. If you do not hear any improvement, then the woofer does not need any boost. Use Bass Boost carefully. The demands on power output are tremendous. Try to minimize its use by changing woofer position or the enclosure size.

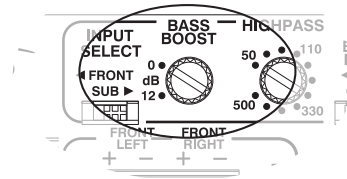

Ohm Load Matching

This amplifier is equipped with a unique impedance matching system that allows you to mix a wide range of Ohm loads and still achieve full power. This can be done independently on the front and rear channels.

Under 4Ω

Any speaker or combination of speakers with a total combined Ohm load between 2 and 4 Ohms (**not lower than 2 Ohms**) must use this position. **Bridged loads down to 4 Ohms must use this position.** The amplifier will make full power at 2 Ohms Stereo (4 Ohms bridged). *Note: you can use any Ohm load above 2 Ohms in this position, however power output will drop as the impedance increases.*

Over 4Ω

Any speaker or combination of speakers with a total combined Ohm load over 4 Ohms can use this position. The amplifier will make full power at 4 Ohms stereo (8 Ohms bridged).

WARNING: This amplifier will not operate and could be damaged if used in the wrong configuration. At no time can it be operated below 2 Ohms stereo or 4 Ohms bridged.

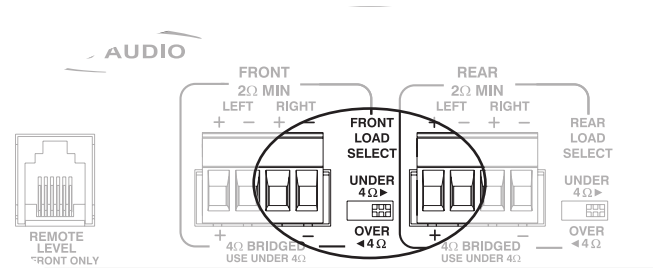

Speaker outputs

This amplifier is a multi channel amplifier design, meaning it has more than one channel of speaker outputs. It is equipped with a removable plug style terminal for speaker wire connections up to 14 AWG. Make this connection carefully and neatly. Strip your wire back 5/16" and twist the exposed leads and insert them into the block terminal while being careful that there are no loose or frayed strands of wire. Tighten the standard head screw down on the terminal until the wire is tightly secured in place. If the wires ever come in contact with each other, the amplifier will go into protection.

Know your total Ohm load before you make any connections.

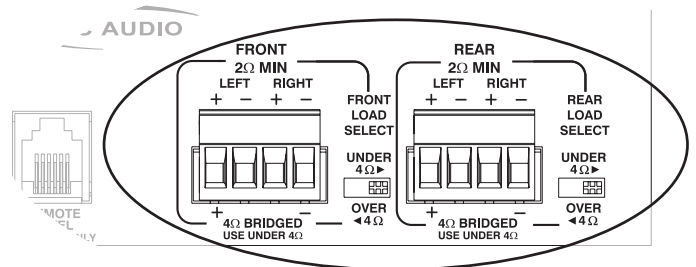

Strip Speaker Wire

Bandpass Crossovers in 250 Words or Less

There are times when you would like to limit a speaker to a specific range of frequencies or sounds. A great example of this is a midrange. You don't want it playing very low frequencies that might damage it. Smoked voice coils smell terrible. To achieve this you need to use Bandpass crossover. A Bandpass will have 2 controls for frequency adjustment. Now here is where it gets confusing. The "Highpass" control takes out the low frequencies. The "Lowpass" filters out the highs. I know, I said it would be confusing but I'll try to make it easier to understand. Highpass means exactly that, it's passing the high frequencies and blocking anything below the point you have set. So literally High Frequencies are Passed (Highpass). Lowpass does just the opposite. It passes low frequencies while filtering out the highs.

OK got that? Here are a couple graphs that might help.

HIGHPASS

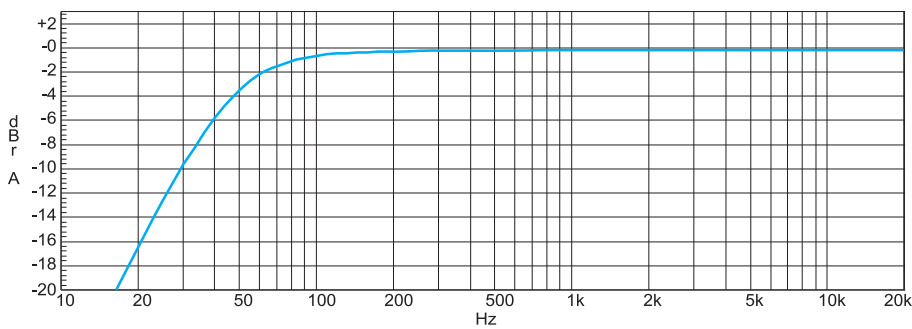

LOWPASS

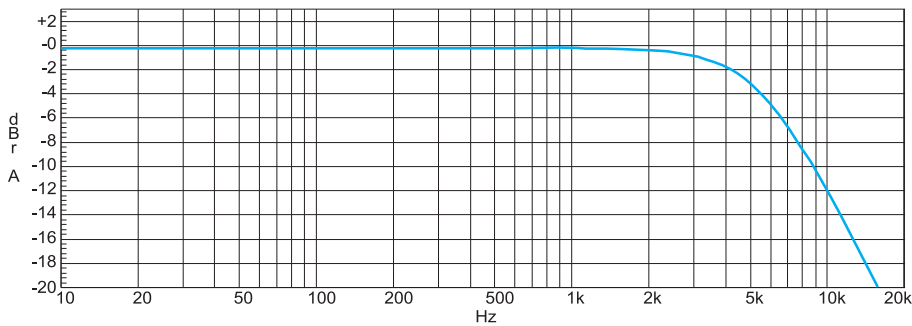

BANDPASS

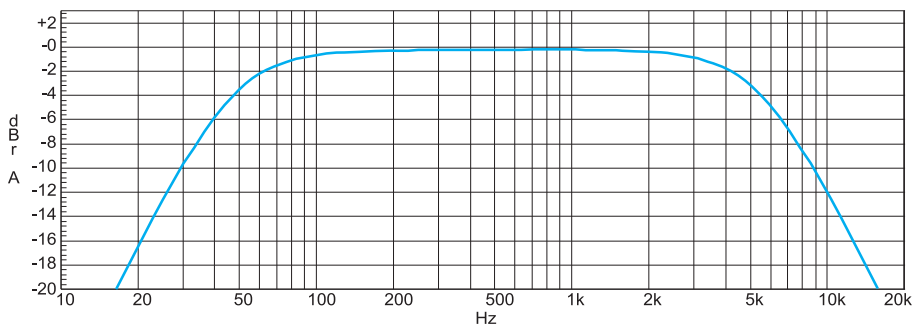

Now I'll introduce you to the controls on the XDi 1200.6.

With the crossover set in Highpass you will be using the highpass frequency control. In this case it is on the far left hand side however this may vary from model to model. If the crossover is set to FULL turning this control will not do anything.

HIGHPASS

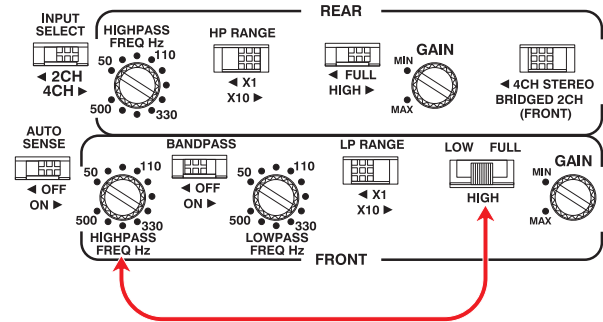

In Lowpass you are using the Lowpass frequency control.

LOWPASS

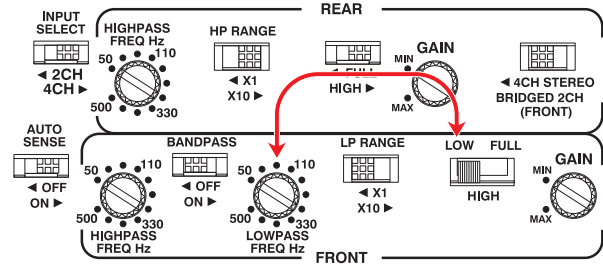

To achieve a Bandpass you need to have to Crossover switch selected to LOW and the Bandpass selected to the ON position. You will now have a working Bandpass.

NOTE: If the Highpass frequency is set higher than the Lowpass frequency the 2 crossovers will overlap and remove almost all signal. It is possible to set this crossover so that nothing can be heard from the speaker.

BANDPASS

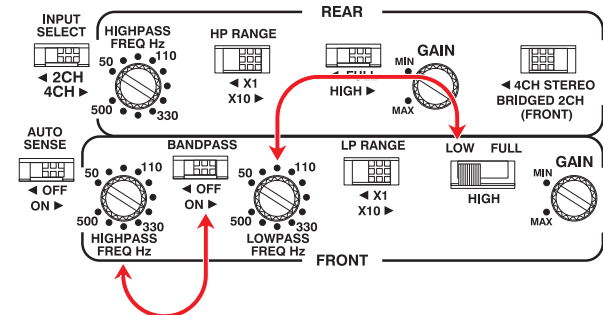

Installation Instructions

Below is a very abbreviated set of installation instructions. This is not meant as a step by step procedure, but is intended to give you a general idea of what is involved and which steps come first. Every installation will be different and may require reordering of these steps. NEVER install the fuse at the battery or connect the negative battery cable until all your connections are final.

Before you start, disconnect the negative cable from any and all batteries in the car. Tape up the end so it is isolated from the battery.

Run an appropriate gauge wire from the battery to the amplifier. Plan this part of the installation carefully. This cable will carry very high current. If it should short to the body and it is not properly fused it could catch fire. **You DID use a grommet when you ran it through the firewall, didn't you?**

Connect the power wire to the battery using a fuse capable of the total current load of all amplifiers connected. **Don't install the fuse yet.** Wait until the end. Locate the fuse as close as possible to the battery. If the fuse is further than 18 inches (wire length) from the battery, you should reevaluate the wire and fuse placement.

Find the closest clear metal area to the amp for a ground. Sand, grind or scrape all paint and undercoating from the body and screw the ground securely in place. A nut, bolt and lock washer is advisable here.

It is advisable to test the ground with an Ohmmeter between the ground cable and the negative battery cable to insure a good low resistance connection. Some alloys used in modern cars do not offer the best ground. If you believe this is the case, consult with the vehicle's manufacturer.

Run the speaker wire to the speakers. It is advised that you leave some extra wire at this point. You can "clean it up" later.

If you haven't already done so, mount the amp now.

Connect the power and ground to the amplifier.

Only after this step should you install the fuse at the battery.

Connect the remote wire from the head unit to the amplifier. Now is a good time to turn on the amp for the first time. Make sure it turns on properly and does not go into protection.

Connect the speaker wires to the amp and speakers (make sure the amp is off first). Make sure the polarity (+ and -) is correct.

Connect the RCA signal wires to the amp.

Double check the amplifier controls at this time. Make sure everything is set correctly for your system.

Now you're ready to play it for the first time. It is best to leave the gain all the way down at first. Start with the head unit volume low and work your way up.

Now you can tune the amp. Take your time and make only one adjustment at a time. It may take some time to get the system fully adjusted. During this time the amp is drawing current from the battery. You should check the battery voltage from time to time and re-charge it if it gets low. That's it. You're done. Now have fun.

XDi 1200.6

4 CHANNEL STEREO WITH BRIDGED SUBWOOFER

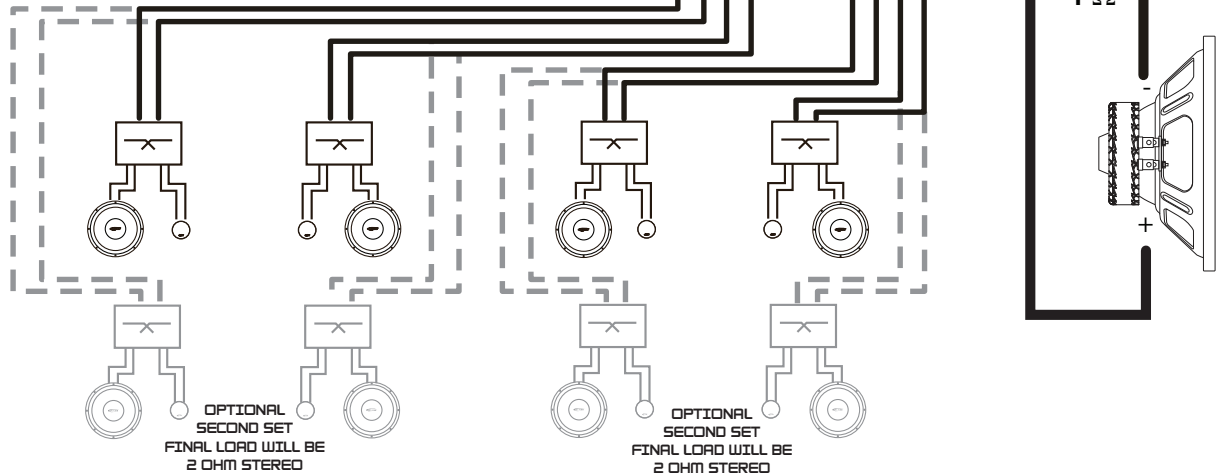
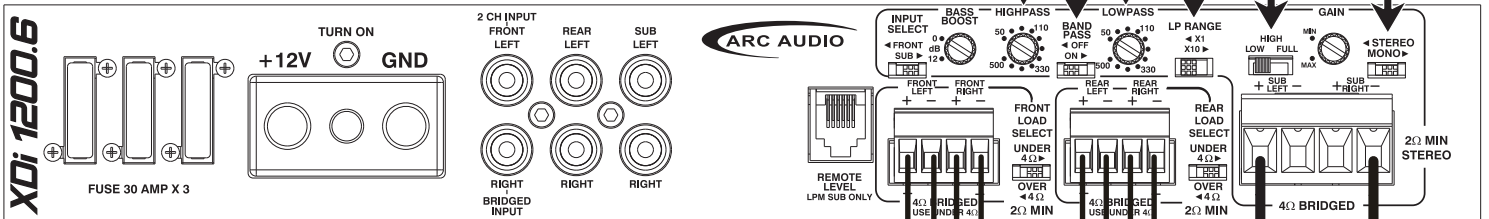
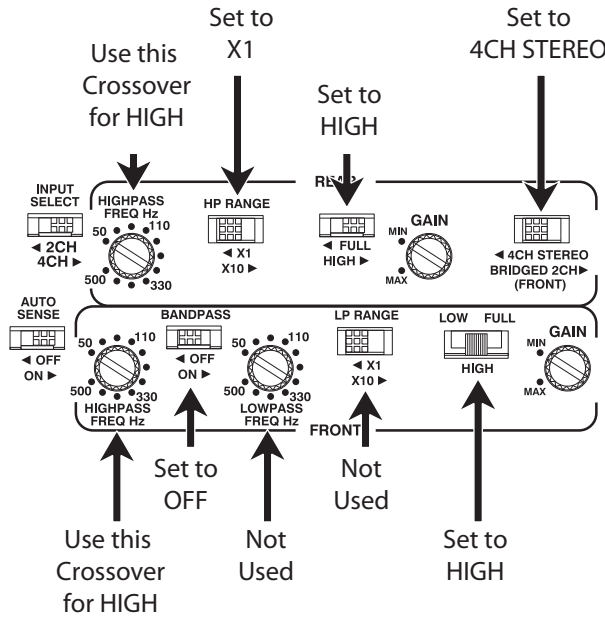

XDi 1200.6

ACTIVE 3-WAY TWEETER/MIDBASS SUBWOOFER

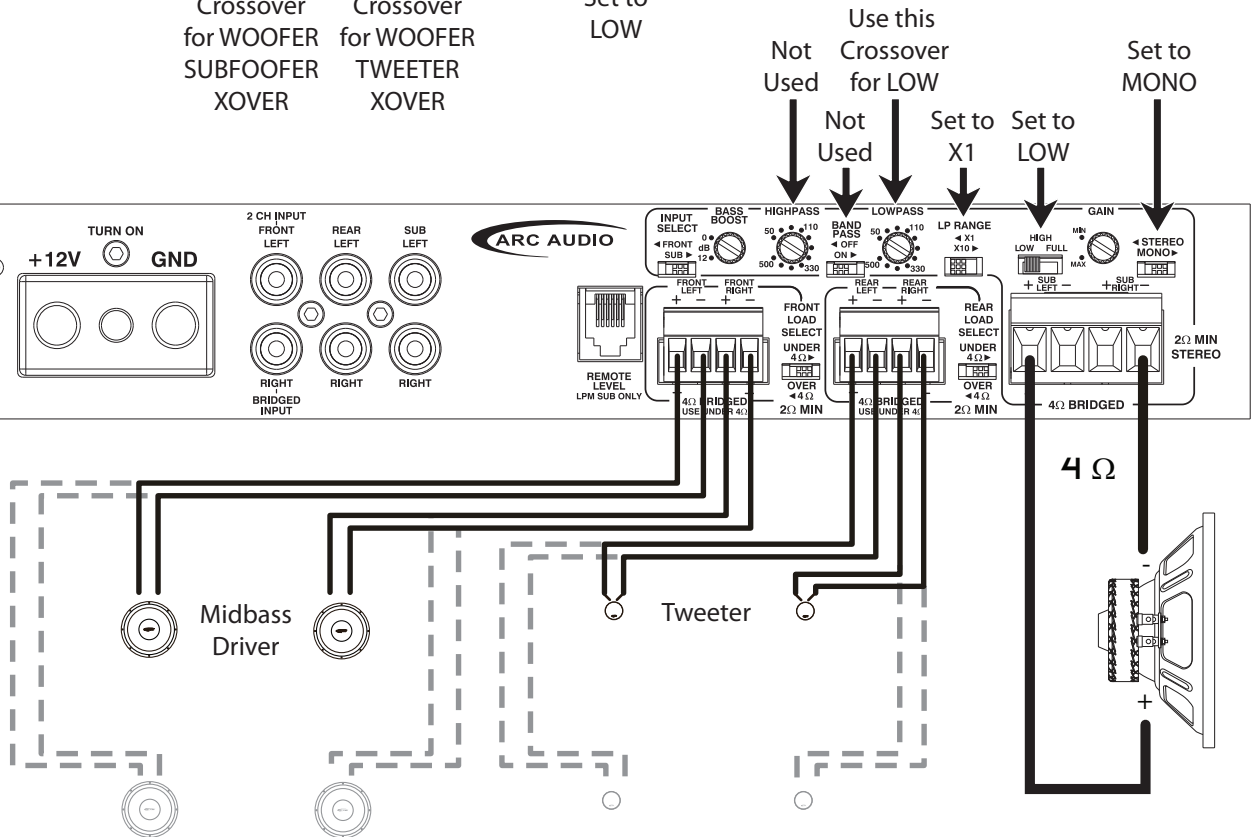
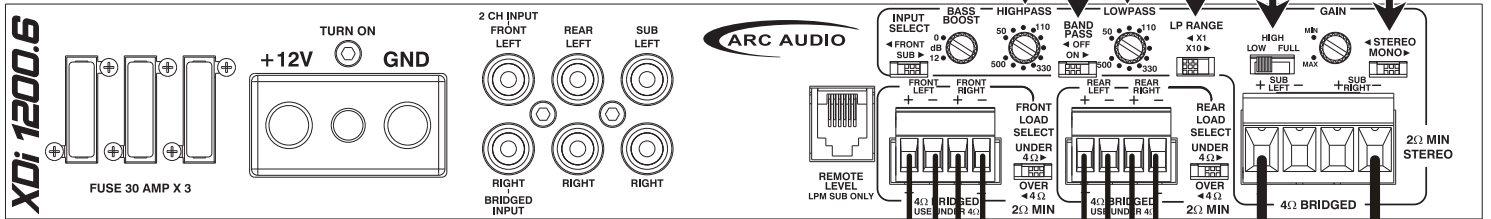
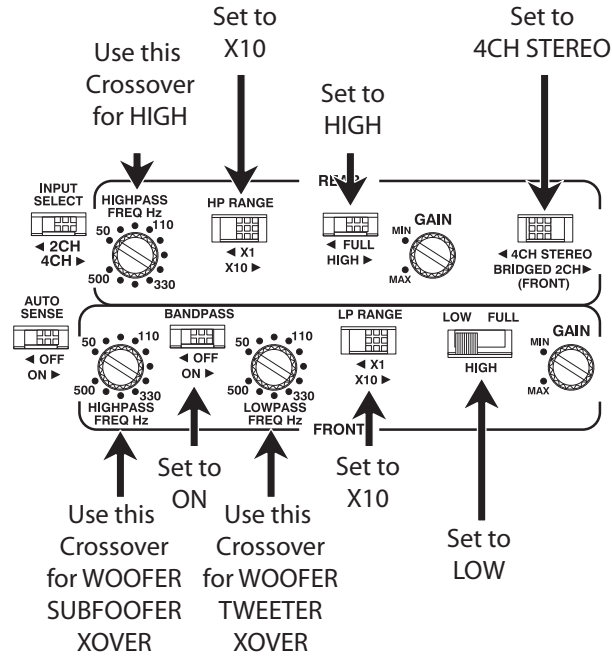

XDi 1200.6

3-WAY MIXED ACTIVE TWEETER/MIDRANGE MIDBASS SUBWOOFER

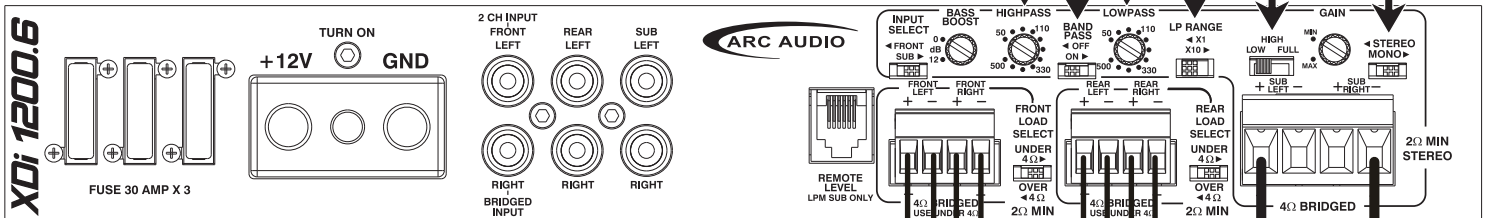
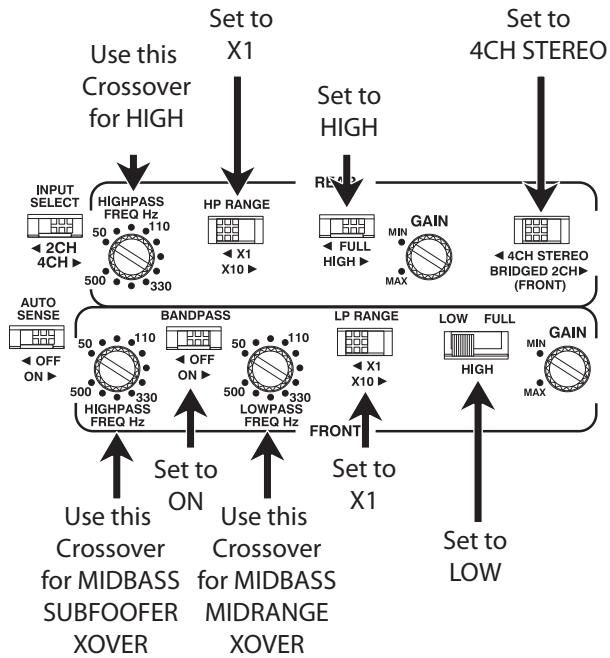

Not Used
 Not Used
 Use this Crossover for LOW
 Set to X1
 Set to LOW
 Set to MONO

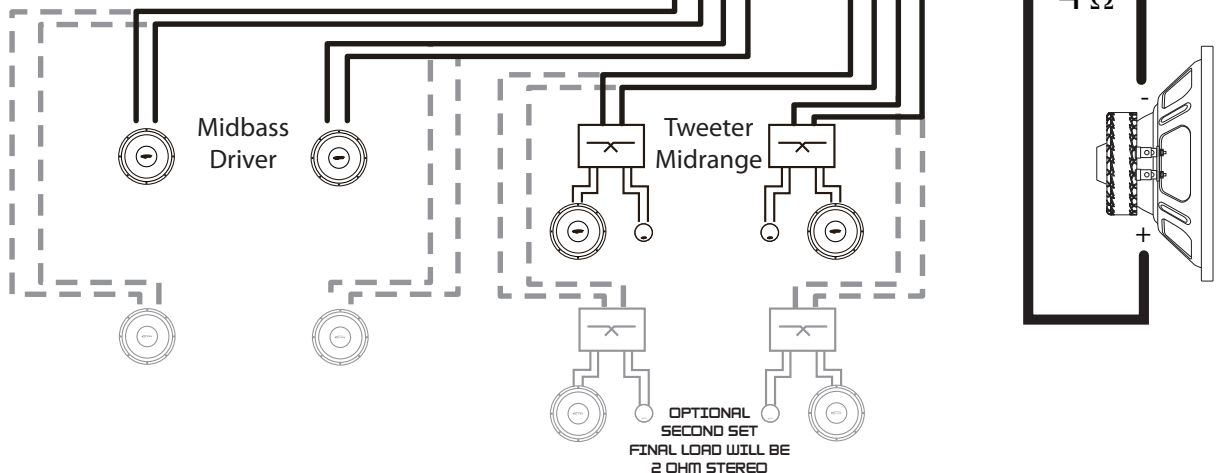

XDi 1200.6

3-WAY ACTIVE TWEETER/MIDRANGE MIDBASS

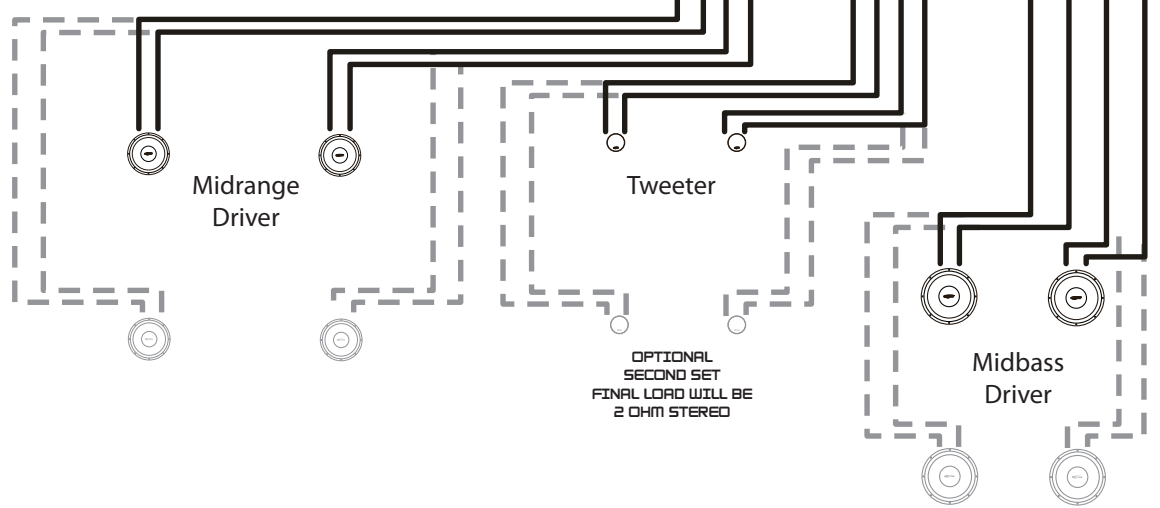
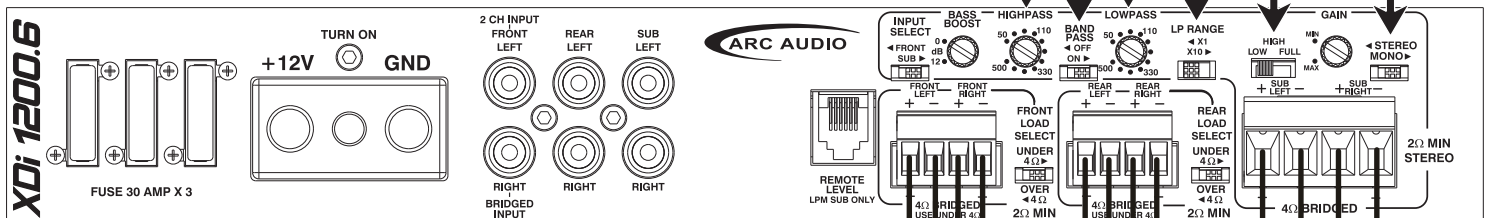
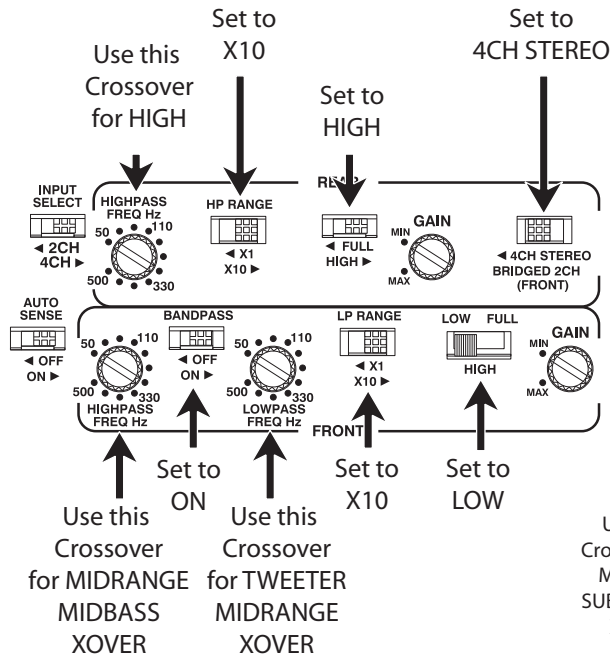

XDi 1200.6

BRIDGED 3 CHANNEL STEREO FRONT WITH SUBWOOFER

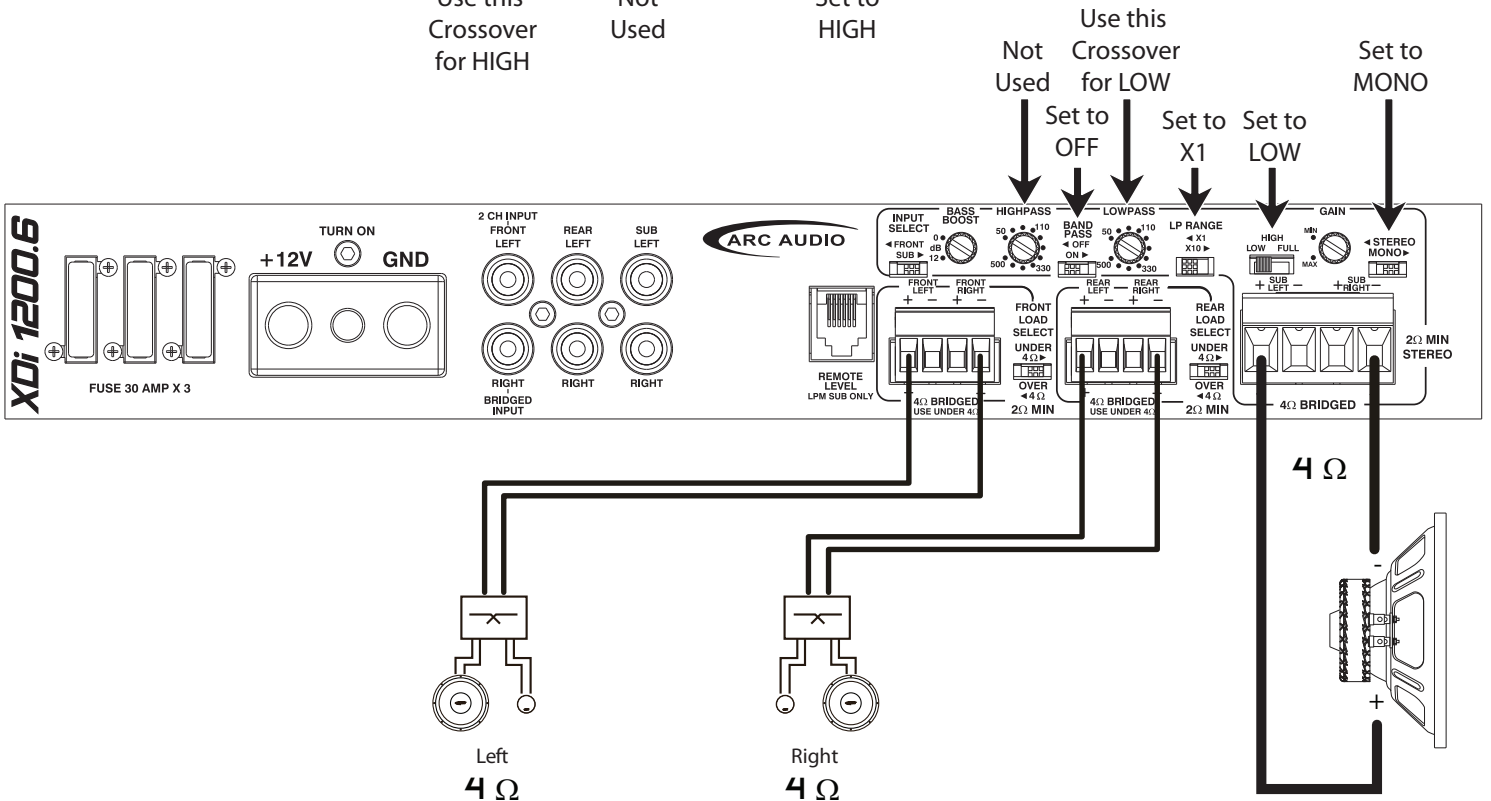
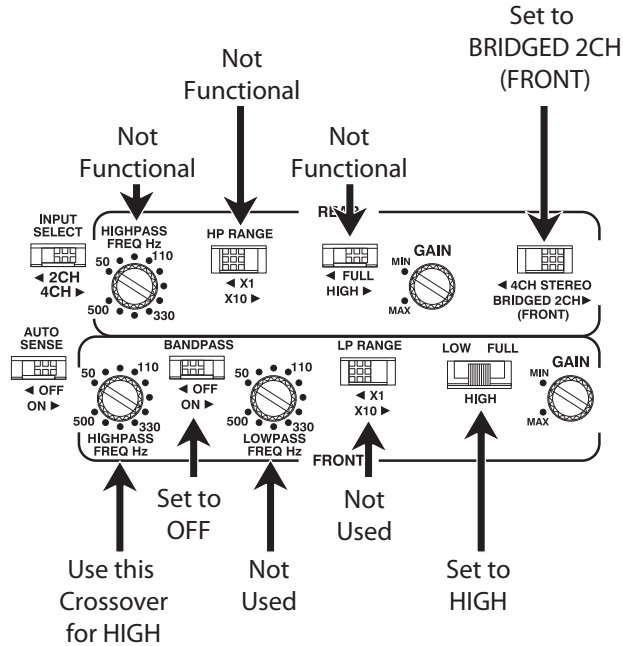

XDi 1200.6 INPUT SELECT SWITCHES

Set to
4CH

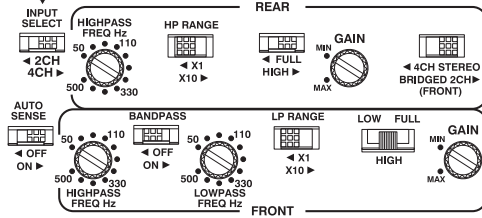

Set to
SUB

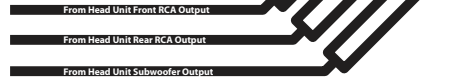
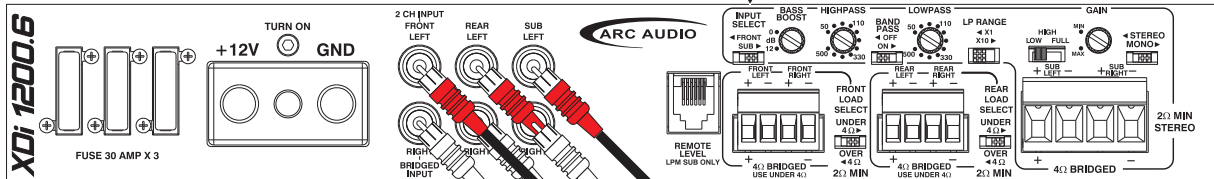

Set to
4CH

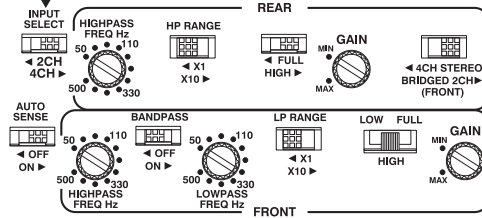

Set to
FRONT

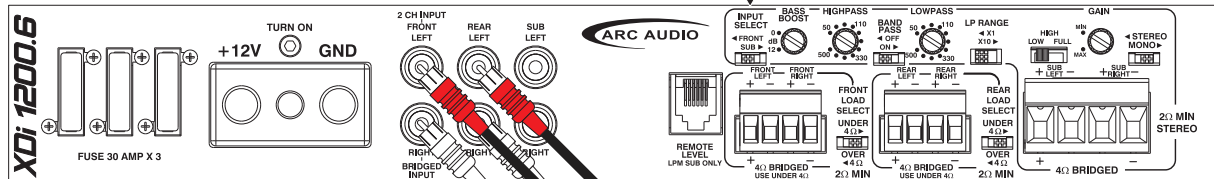

Set to
2CH

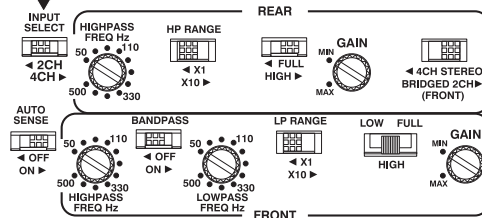

Set to
FRONT

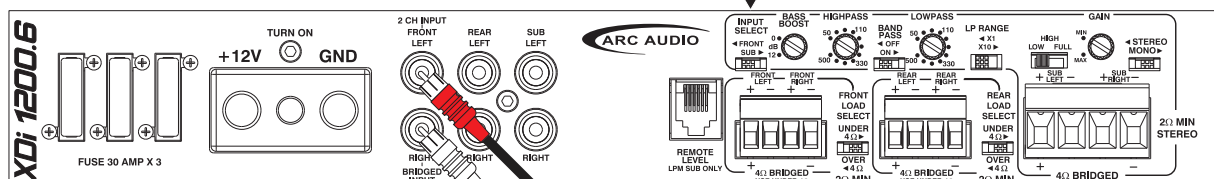

XDi 1200.6 AUTO DETECT SPEAKER LEVEL INPUT

AUTO SENSE

The XDi 1200.6 uses BTLD (Bridge Tied Load Detect) Turn-on circuit that offers a significant improvement in reliability over previous designs. Instead of relying on the music to supply enough signal to turn the amplifier on, Robert Zeff's design detects the IC (chip) used in the vast majority of stock head units and amplifiers.

It is important to note the Auto Sense will not always work. Do to the hundreds (or thousands) of different OEM system configurations, no single solution can be 100% successful. If your system does not reliably switch on and off, look for an alternative turn on source. It is possible to spend many hours trouble shooting an Auto Sense problem. This is time that could be spend enjoying your new audio system.

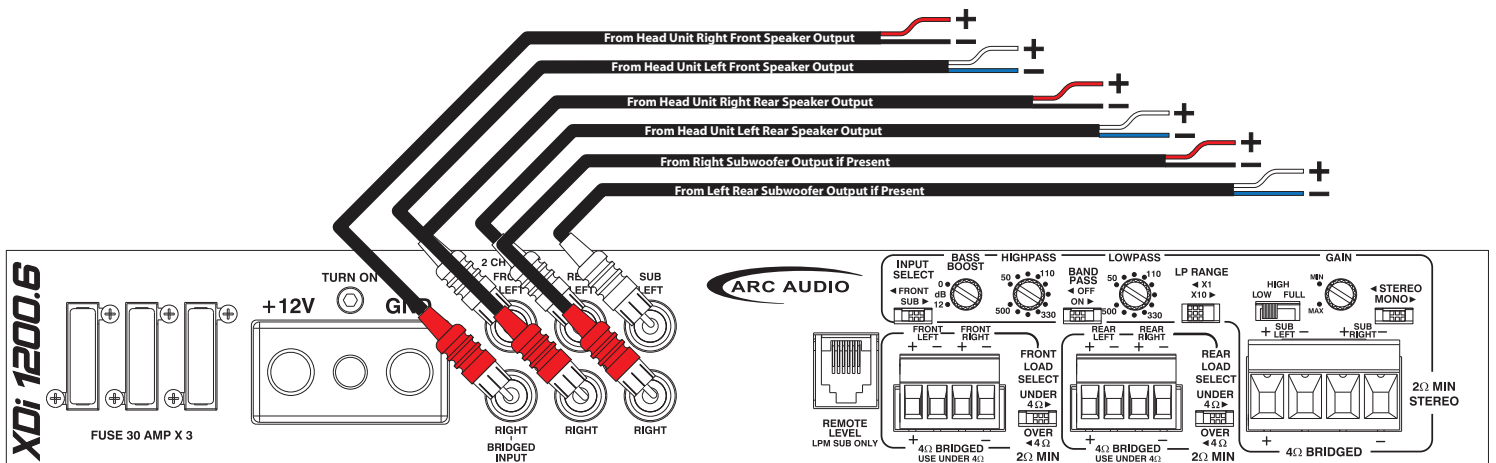
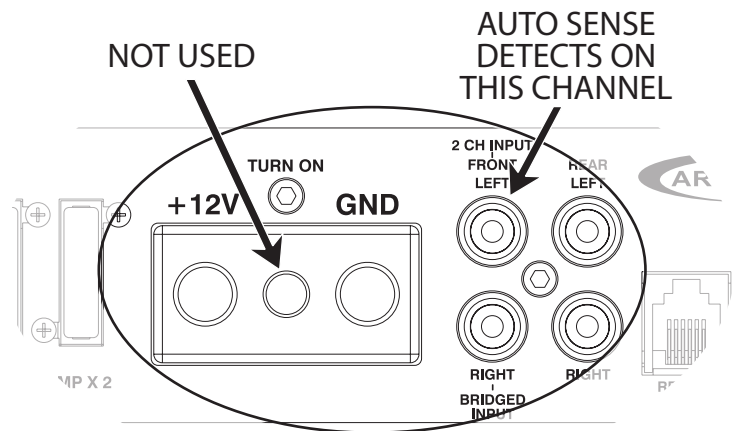
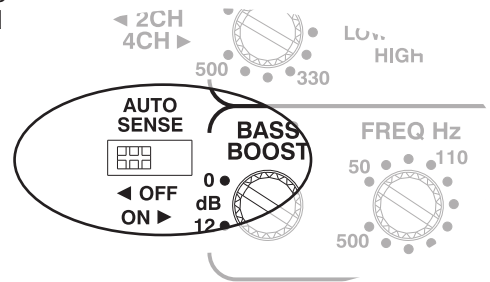

SPECIFICATIONS

FOUR CHANNEL AMPLIFIERS

XDi 450.4 XDi 600.4

4 Channels @ 4 ohms-	85 Watts	150 Watts
4 Channels @ 2 ohms-	125 Watts	150 Watts
2 Channel @ 4 ohms-	250 Watts	300 Watts
Frequency Response-	20Hz - 20kHz	20Hz - 20kHz
Total Harmonic Distortion	.08% THD	.02% THD
Bass Boost-	12dB @45Hz(Rear only)	12dB@45Hz(Front Only)
Remote Included-	No	Yes
XDi Trim Kit-	Not Included	Included
Dimensions-	8.173"(L) x 6.268"(W) x 2.086" (H)	9.020" (L) x 6.268" (W) x 2.162 (H)

FIVE CHANNEL AMPLIFIERS

XDi850.5 XDi1100.5

4 Channels @ 4 ohms-	85 Watts	150 Watts
4 Channels @ 2 ohms-	125 Watts	150 Watts
2 Channel @ 4 ohms-	250 Watts	300 Watts
1 Channel @ 4 ohms-	225 Watts _(Sub Channel)	275 Watts _(Sub Channel)
1 Channel @ 2 ohms-	400 Watts _(Sub Channel)	500 Watts _(Sub Channel)
Frequency Response-	20Hz - 20kHz	20Hz - 20kHz
Frequency Response _(sub) -	20Hz - 230Hz	20Hz - 230Hz
Total Harmonic Distortion	.08% THD	.02% THD
Bass Boost _(Sub Ch) -	12dB@45Hz	12dB@45Hz
Remote Included-	Yes	Yes
XDi Trim Kit	Not Included	Included
Dimensions-	12.42"(L) x 6.268"(W) x 2.086" (H)	12.42"(L) x 6.268"(W) x 2.162" (H)

MONO BLOCK AMPLIFIERS

XDi650.1 XDi1100.1

1 Channels @ 4 ohms-	185 Watts	350 Watts
1 Channels @ 2 ohms-	350 Watts	600 Watts
1 Channel @ 1 ohms-	650 Watts	1100 Watts
Frequency Response-	20Hz - 230Hz	20Hz - 230Hz
Total Harmonic Distortion	.05% THD	.06% THD
Bass Boost-	12dB@30-125Hz	12dB@30-125Hz
Remote Included-	Yes	Yes
XDi Trim Kit-	Not Included	Included
Dimensions-	9.02"(L) x 6.268"(W) x 2.086" (H)	13.0" (L) x 6.268" (W) x 2.162 (H)

SIX CHANNEL AMPLIFIERS

XDi1200.6

4 Channels @ 4 ohms-	150 Watts
4 Channels @ 2 ohms-	150 Watts
2 Channels @ 4 ohms-	300 Watts
2 Channels @ 4 ohms-	150 Watts (Ch 5&6)
2 Channel @ 2 ohms-	300 Watts (Ch 5&6)
1 Channel @ 4 ohms-	600 Watts (Ch 5&6)
Frequency Response-	20Hz - 20kHz
Total Harmonic Distortion	.02% THD
Bass Boost-	12dB @ 45Hz (Ch 5&6)
Remote Included-	Yes
XDi Trim Kit-	Included
Dimensions-	13.0"(L) x 6.268"(W) x 2.162" (H)

ARC AUDIO WARRANTY

ARC AUDIO warranties all new XDi Amplifiers against defects in material and workmanship for a period of **ONE (1) YEAR** from the original date of purchase. **This warranty is not transferable and applies only to the original retail purchaser of the product from an authorized ARC AUDIO retailer.** Upon inspection by ARC AUDIO should services be necessary under this warranty for any reason due to manufacture defects ARC AUDIO will, at its sole discretion, repair or replace the defective product with new or similar conditioned product at no charge.

THIS WARRANTY DOES NOT COVER INSTALLATION OR DAMAGE RESULTING FROM ACCIDENT, MISUSE, ABUSE, IMPROPER WIRING, OPERATION OUTSIDE OF THE MANUFACTURER'S RECOMMENDATIONS OR SPECIFICATIONS, OR AGAINST INSTRUCTIONS IN THE OWNERS MANUAL. IN ADDITION ANY PRODUCT THAT HAS BEEN OPENED, TAMPERED WITH OR MODIFIED, OR IF ANY SERIAL NUMBERS HAVE BEEN REMOVED WILL NOT BE COVERED BY ANY PART OF THE MANUFACTURERS WARRANTY.

All warranty returns should be sent to ARC AUDIO freight prepaid and must be accompanied by proof of purchase (a copy of the original sales receipt). Direct returns from consumers or non-authorized retailers will be refused unless specifically authorized by ARC AUDIO with a valid return authorization number.

All warranty returns should be packed in original packaging and must be accompanied by a copy of the original sales receipt. Product damaged in shipment will not be covered under this warranty. The customer or retailer may choose to have this damage repaired at the normal "Out of Warranty" repair cost.

In no event will ARC AUDIO be liable for incidental, consequential, or other damages resulting from the use of this product, this includes but is not limited to, damage of hearing, property or person, damage based upon inconvenience or on loss of use of the product, and to the extent permitted by law, damages for personal injury. This warranty gives you specific legal rights, and you may have other rights, which vary from state to state. This warranty applies to products sold and used in the United States of America. In all other countries please contact your distributor

[PRODUCTS](#)
[REVIEWS](#)
[CATALOGS](#)
[GALLERIES](#)
[ARC TECH](#)
[DEALER / REP LOCATOR](#)
YOU ARE HERE: [HOME](#) » [WARRANTY POLICY](#)

WARRANTY POLICY

Warranty Policy



Product Warranty & Repair

[CLICK HERE TO REQUEST A RETURN AUTHORIZATION NUMBER](#)

Note to International Customers-

For warranty and repair service outside of the USA, please send your product directly to your countries authorized Arc Audio distributor for your service needs. As a customer you do have the option to send your product directly back to the factory in the USA but you will be responsible for "ALL" shipping costs, taxes, and duties to and from the USA. Return shipping charges and fee's must be paid by Credit Card with a signed credit card authorization form prior to the return shipment. This includes shipping cost, customs fee's, duties, local and government import/export tax's, broker's fee's and any other misc. fee's that could be added by your local government or other international agencies. International warranty shipments will not be accepted without a proper return authorization number, sales receipt documentation FROM AN AUTHORIZED INTERNATIONAL RETAILER OR DISTRIBUTOR. Any international shipments not received with all incoming duties and customs prepaid will immediately refused and returned to the sender.

ARC AUDIO WARRANTY AND SERVICE GUIDELINES

*ARC AUDIO warrants all new products against defects in material and workmanship for a period of **ONE (1) YEAR** from the original date of purchase from an **AUTHORIZED ARC AUDIO RETAILER**.*

This warranty is not transferable and applies only to the original retail purchaser of the product from an authorized ARC AUDIO retailer. Upon inspection by ARC AUDIO should services be necessary under this warranty for any reason due to manufacture defects ARC AUDIO will, at its sole discretion, repair or replace the defective product with new or similar conditioned product at no charge.

THIS WARRANTY DOES NOT COVER INSTALLATION OR DAMAGE RESULTING FROM ACCIDENT, MISUSE, ABUSE, IMPROPER WIRING, OPERATION OUTSIDE OF UNIT OUTSIDE OF MANUFACTURES SPECIFICATIONS, OR AGAINST INSTRUCTIONS IN OWNERS MANUAL. IN ADDITION ANY PRODUCT THAT HAS BEN OPENED, TEMPERED WITH OR MODIFIED, OR IF ANY SERIAL NUMBERS HAVE BEEN REMOVED OR ALTERED WILL NOT BE COVERED BY ANY PART OF THE MANUFACTURES WARRANTY.

All warranty returns should be sent to ARC AUDIO freight prepaid and must be accompanied by proof of purchase (a copy of the original sales receipt). Direct returns from consumers or non-authorized retailers will be refused unless specifically authorized by ARC AUDIO with a valid return authorization number.

All warranty returns must be packed in original packaging and be accompanied by a copy of the original printed sales receipt. Product damaged in shipment due to improper packaging will not be covered under this warranty and the customer or retailer will be charged full cost to repair the specific piece of product back to a like new or similar condition.

In no event will ARC AUDIO be liable for incidental, consequential, or other damages resulting from the use of this product, this includes but is not limited to, damage of hearing, property or person, damage based upon inconvenience or on loss of use of the product, and to the extent permitted by law, damages for personal injury. This warranty gives you specific legal rights, and you may have other rights, which vary from state to state. This warranty ap-

plies to products sold and used in the United States of America. In all other countries please contact your distributor.

The following are examples of what is not covered under Arc Audio's warranty policy-

- Any Product that is missing or has altered/damaged Serial numbers
- Any Product that has been damaged as a result of physical abuse
- Any Product that has been modified or altered from its original form or design and/or repair has been attempted by unauthorized repair facilities.
- Any product that has been previously owned by another user and was sold private party. (Arc Audio's warranty policy is not transferable to third party or second hand users)
- Any product purchased from ANY form of online marketplace (web sites, EBay or similar auction site, web site talk forum sales, etc)
- Any product not purchased at a brick and mortar authorized store front location.
- Any Speaker or Subwoofer that has been damaged to over-powering causing burnt voice coils and/or mechanical failures such as ripped spiders or surrounds.
- Product that has not been installed as per manufacture recommendations including wiring and installation related damage to product.
- Cosmetic damage due to installation, shipping and handling, and normal wear and tear.
- Arc Audio will not be responsible for any product that has any kind of custom finish or customized cosmetic additions that differs from the original form as manufacture from Arc Audio.
Products damaged by "Acts of God" (Flood, Fire, Infestations, etc.)